

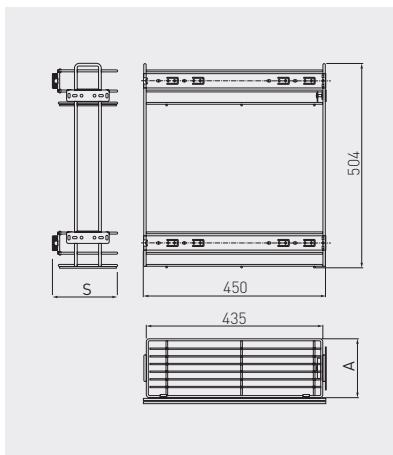







Cargo boczne na prowadnicy kulkowej H35

Side cargo on a H35 ball bearing slide

Выдвижная корзина с боковым креплением на шариковых направляющих H35



		 mm	 mm	 mm				
KO-CMB150-PW-01	lewy / prawy left / right левый / правый	150	95	110	ocynk galwanizacja гальваника	chrom chrome хром	stal steel сталь	
KO-CMB200-PW-01*		200	145	160				
KO-CMB300-PW-01*		300	245	260				
KO-CMB150-PW-10		150	95	110		ocynk galwanizacja гальваника		biały white белый
KO-CMB200-PW-10*		200	145	160				
KO-CMB300-PW-10*		300	245	260				
KO-CMB150-PW-OC		150	95	110		ocynk galwanizacja гальваника		srebrny silver серебристый
KO-CMB200-PW-OC		200	145	160				
KO-CMB300-PW-OC*		300	245	260				



\*Produkt dostępny na indywidualne zamówienie / Available for special orders / Товар доступен под заказ